

YDS-Z6MF-OV9281 V3.0

1MP OmniVision OV9281 Global Shutter MIPI Interface M12 Fixed Focus Camera Module



Front View



Back View

Specifications

Camera Module No.	YDS-Z6MF-OV9281 V3.0
Resolution	1MP
Image Sensor	OV9281 Global Shutter
Sensor Type	1/4"
Pixel Size	3.0 um x 3.0 um
EFL	2.33 mm
F.NO	2.50
Pixel	1296 x 816
View Angle	120.0°(DFOV) 99.0°(HFOV) 55.0°(VFOV)
Lens Dimensions	13.10 x 13.10 x 12.82 mm
Module Size	200.00 x 22.00 mm
Module Type	Fixed Focus
Interface	MIPI
Auto Focus VCM Driver IC	None
Lens Type	650nm IR Cut
Operating Temperature	-30°C to +85°C
Mating Connector	FH33-28S-0.5SH(10)



YDS-Z6MF-OV9281 V3.0

**1MP OmniVision OV9281 Global Shutter MIPI Interface
M12 Fixed Focus Camera Module**



Top View



Side View



Bottom View



Mating Connector

Real Test Images
Z6MF-OV9281 V3.0

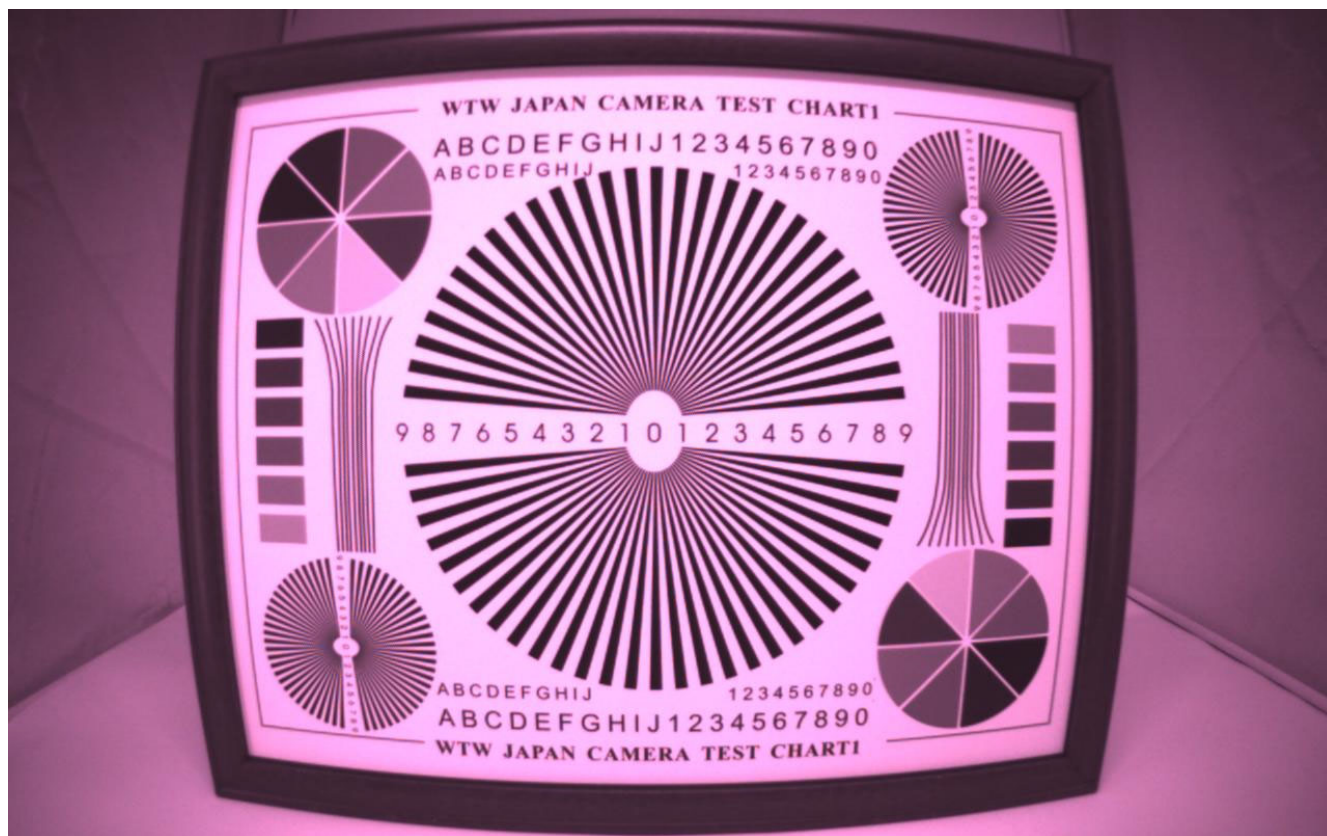

Real Test Images Z6MF-OV9281 V3.0

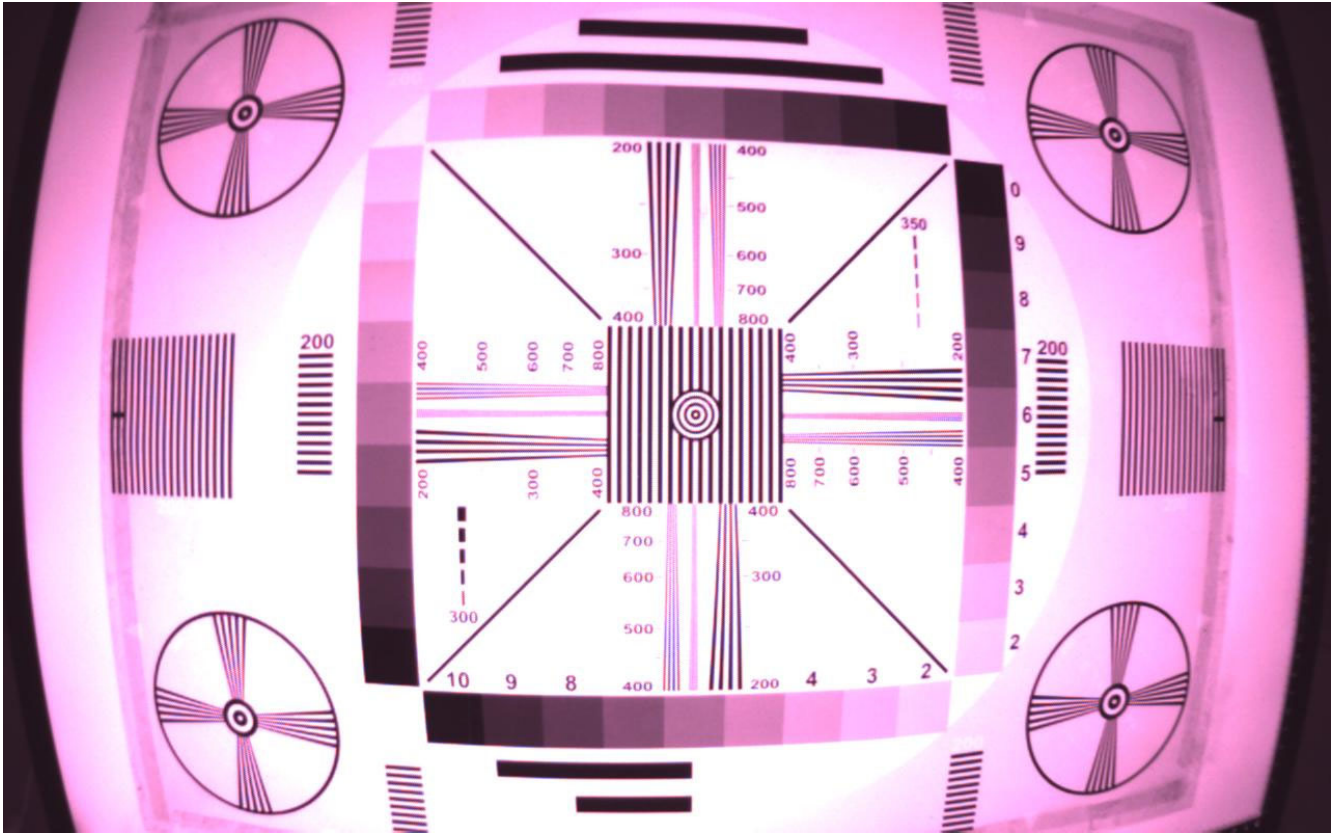

Real Test Images
Z6MF-OV9281 V3.0



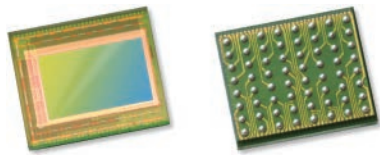

OV9281-OV9282 1-megapixel product brief



1-Megapixel OmniPixel®3-GS Sensors for Computer Vision Applications



available in a lead-free package

OmniVision's OV9281 and OV9282 are high-speed global shutter image sensors that bring 1-megapixel resolution to a wide range of consumer and industrial computer vision applications, including augmented reality (AR), virtual reality (VR), collision avoidance in drones, bar code scanning and factory automation. Built on OmniVision's OmniPixel®3-GS pixel technology, the OV9281 and OV9282 feature a high-speed global shutter pixel with best-in-class near-infrared (NIR) quantum efficiency (QE) to meet high-resolution and low-latency requirements.

Special features of the OV9281 and OV9282 include region of interest (ROI) selection and context switching. This allows some of the camera settings to change dynamically as fast as alternating frames. The sensors are available in both narrow and wide chief ray angle (CRA) settings.

The 1/4-inch OV9281 and OV9282 capture 1280 x 800 resolution images at 120 frames per second (fps) and VGA resolution at 180 fps with 2-lane MIPI and DVP output. The OV9281 and OV9282 also feature support for frame synchronization and dynamic defective pixel correction.

The OV9281 has a chief ray angle (CRA) of 9 degrees and comes in a chip scale package (CSP). The OV9282 features a CRA of 27 degrees and is available in a reconstructed wafer (RW) format. Both sensors are currently available in volume production.

Find out more at www.ovt.com.



Applications

- Consumer HMD
- Drones
- Machine Vision
- PCNB

Product Features

- 3 μm x 3 μm pixel with OmniPixel³-GS technology
- automatic black level calibration (ABLC)
- programmable controls for:
 - frame rate
 - mirror and flip
 - cropping
 - windowing
- support output formats: 8/10-bit RAW
- fast mode switching
- supports 2x2 monochrome binning
- two-lane MIPI serial output interface
- DVP parallel output interface
- supports horizontal and vertical 2:1 and 4:1 monochrome subsampling
- support for image sizes:
 - 1280 x 800
 - 1280 x 720
 - 640 x 480
 - 640 x 400
- embedded 256 bits of one-time programmable (OTP) memory for part identification
- two on-chip phase lock loops (PLLs)
- LED PWM
- built-in strobe control

OV9281-OV9282

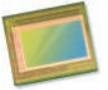

Ordering Information

- **OV9281-H64A**
(b&w, lead-free) 64-pin CSP
- **OV9282-GA4A**
(b&w, lead-free, 200 μm backgrinding, reconstructed wafer with good die)

Technical Specifications

- **active array size:** 1296 x 816
- **maximum image transfer rate:**
- 1280 x 800: 120 fps
- **power supply:**
 - analog: 2.8V (nominal)
 - core: 1.2V (nominal)
 - I/O: 1.8V (nominal)
- **power requirements:**
 - active: 156 mW
 - standby: 150 μA
 - XSHUTDOWN: 150 μA
- **temperature range:**
 - operating: -30°C to +85°C junction temperature
 - stable image: 0°C to +50°C junction temperature
- **output interfaces:** 2-lane MIPI serial output and DVP parallel output
- **output formats:** 8/10-bit RAW
- **lens size:** 1/4"
- **lens chief ray angle:**
 - OV9281: 9° linear
 - OV9282: 26.78° non-linear
- **scan mode:** progressive
- **pixel size:** 3 μm x 3 μm
- **image area:** 3896 μm x 2453 μm

Functional Block Diagram

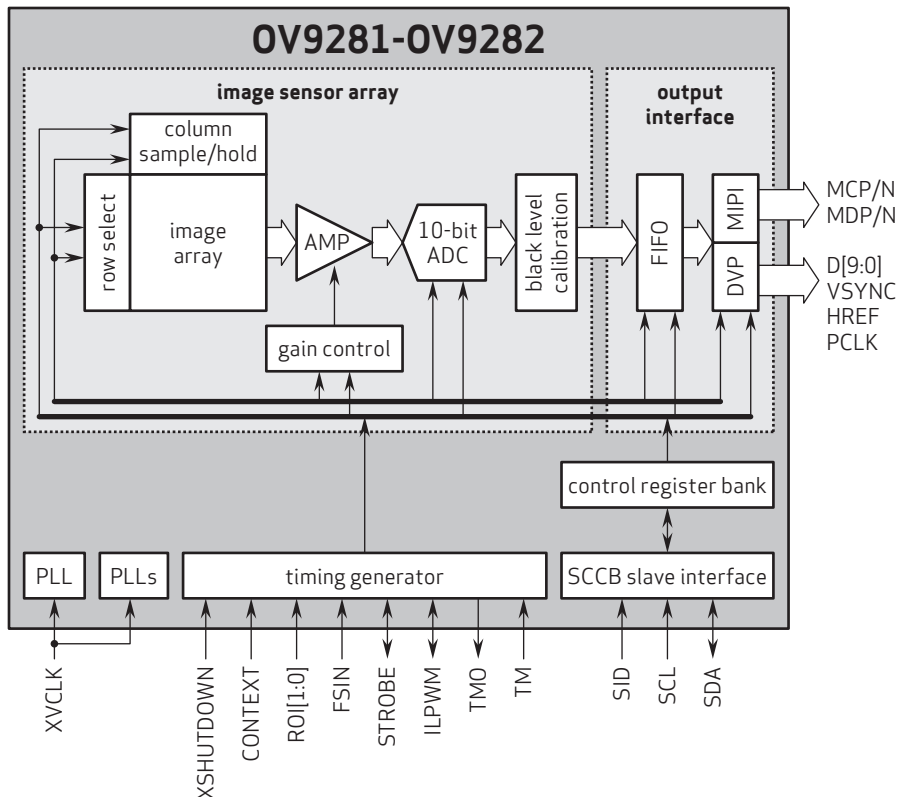

4275 Burton Drive
Santa Clara, CA 95054
USA

Tel: + 1 408 567 3000
Fax: + 1 408 567 3001
www.ovt.com

OmniVision reserves the right to make changes to their products or to discontinue any product or service without further notice. OmniVision, the OmniVision logo and OmniPixel are registered trademarks of OmniVision Technologies, Inc. All other trademarks are the property of their respective owners.



OmniVision

FH33 Series

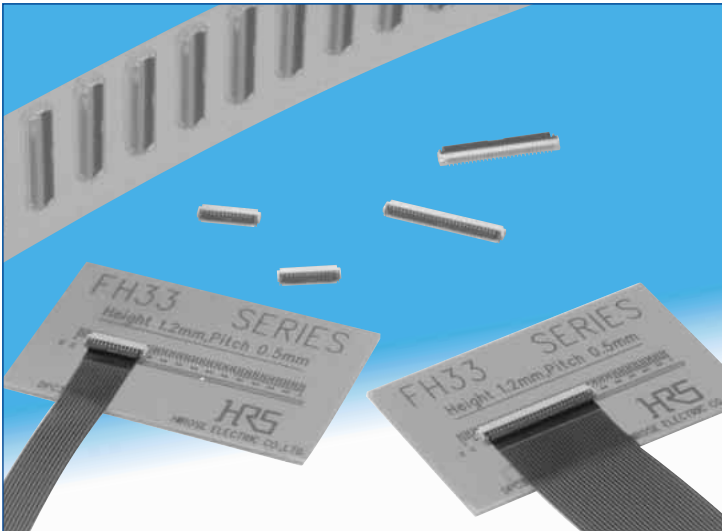

Features

1. Low-profile, small PCB mounting area

Narrow width of only 2.5 mm reduced the board footprint by approximately 17% to 57%, as compared to several similar FH Series HRS connectors.

2. Various contact pitch (0.4mm, 0.5mm, 1mm pitch) available

In addition to standard 0.5mm pitch, 0.4mm pitch, 1mm pitch also available.

3. Increased FPC/FFC retention force

- In the horizontal direction: Approximately 2.0 times (compared to 0.5mm pitch FH12 series.)
- In the vertical direction: Approximately 1.7 times (compared to 0.5mm pitch FH19 series.)

4. Conductive traces on the PCB can run under the connector

No exposed contacts on the bottom of the connector.

5. One finger operation of the actuator

Proven (in several other Hirose's connectors) Flip-Lock® rotating actuator assures reliable mechanical and electrical connection with FPC/FFC, confirming it with a definite tactile feel.

6. Easy FPC insertion and reliable electrical connection

Proven Flip Lock actuator allows easy insertion of FPC/FFC and provides a tactile sensation when fully closed, confirming complete electrical and mechanical connection.

7. Accepts standard FPC thickness

0.3mm thick standard Flexible Printed Circuit (FPC) and Flexible Flat Cable (FFC) can be used.

8. Board placement with automatic equipment

Flat upper surface and tape and reel packaging facilitate vacuum pick-up and placement. Standard reel packaging contains 5000 connectors.

9. Halogen-free* (FH33J Series)

*As defined by IEC61249-2-21
Br-900ppm maximum, Cl-900ppm maximum,
Cl + Br combined-1,500ppm maximum

Increased FPC retention force

● Small size

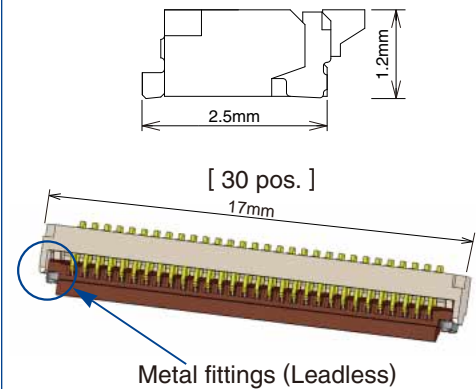

● Can be mounted over conductive traces.

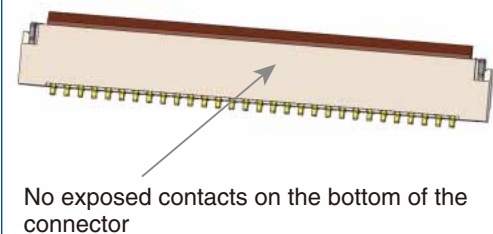

● Simple operation

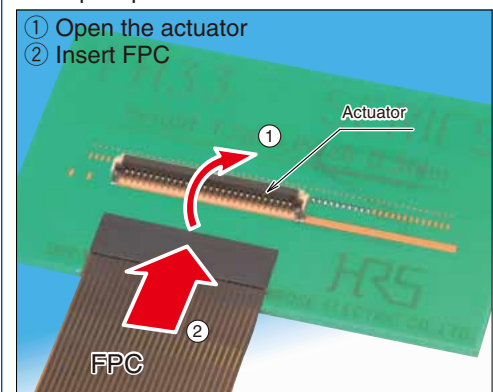

● Locked condition

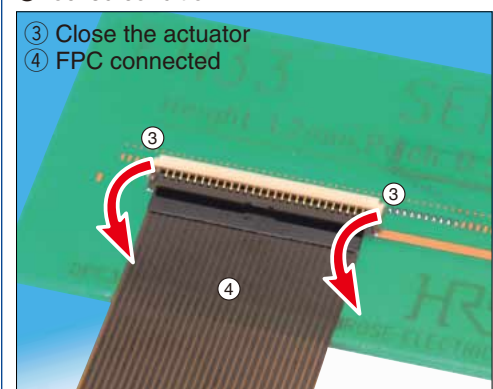

Product Specifications

Ratings	Current rating	0.5 A (0.4mm pitch type 0.4A)	Operating temperature range	-55 °C to +85°C (Note 1)	Storage temperature range	-10°C to +50°C (Note 2)
	Voltage rating	50 V AC (0.4mm pitch type 40V AC)		Operating humidity range		Relative humidity 90% max. (No condensation)

Recommended FPC	Thickness = 0.3 ± 0.05mm gold plated (under 30 pos.), 0.3 ± 0.03mm gold plated (over 31 pos.)
-----------------	---

Item	Specification	Conditions
1. Insulation resistance	500 MΩ min.	100 V DC
2. Withstanding voltage	No flashover or insulation breakdown.	150 V AC /one minute, 120 V AC /one minute(0.4mm pitch type)
3. Contact resistance	50 mΩ max. 100 mΩ max(0.4mm pitch type). * Including FPC conductor resistance	1 mA
4. Durability (insertion/ withdrawal)	Contact resistance: 50 mΩ max. 100 mΩ max(0.4mm pitch type). No damage, cracks, or parts dislocation.	20 cycles
5. Vibration	No electrical discontinuity of 1μs or more. Contact resistance: 50 mΩ max. 100 mΩ max(0.4mm pitch type).	Frequency: 10 to 55 Hz, single amplitude of 0.75 mm, 10 cycles in each of the 3 directions.
6. Shock	No damage, cracks, or parts dislocation.	Acceleration of 981 m/s ² , 6 ms duration, sine half-wave waveform, 3 cycles in each of the 3 axis
7. Humidity (Steady state)	Contact resistance: 50 mΩ max. 100 mΩ max(0.4mm pitch type).	96 hours at 40°C and humidity of 90% to 95%.
8. Temperature cycle	Insulation resistance: 50 MΩ min. No damage, cracks, or parts dislocation.	Temperature : -55°C→+15°C to +35°C→+85°C→+15°C to +35°C Time : 30 → 2 to 3 → 30 → 2 to 3 (Minutes) 5 cycles
9. Resistance to soldering heat	No deformation of components affecting performance.	Reflow : At the recommended temperature profile Manual soldering: 350°C ± 10°C for 5 seconds

Note 1: Includes temperature rise caused by current flow.

Note 2: The term "storage" refers to products stored for long period of time prior to mounting and use. Operating Temperature Range and Humidity range covers non- conducting condition of installed connectors in storage, shipment or during transportation.

Materials

Part	Material	Finish	Remarks	
Insulator	FH33 series	PA	UL94V-0	
		Color:Beige		
	FH33J series	LCP		Color:Deep brown
		PPS		Color:Beige
	FH33M series	LCP		Color:Black
		PA		Color:Beige
	FH33MHJ series	LCP		Color:Deep brown
PPS		Color:Beige		
Contacts	Phosphor bronze	Gold flash plated	---	
Metalfittings		Pure tin reflow plated	---	

Ordering information

FH 33 M H J - 12 (6) S B - 1 SH (10)

① ② ③ ④ ⑤ ⑥ ⑦ ⑧ ⑨ ⑩ ⑪ ⑫

① Series name:FH	④ Blank:Width 3.0mm(standard) H:Width 3.5mm(long actuator type)	⑦ Standard type:Blank Eccentric type:Number of contacts	⑩ Contact pitch: 0.4mm,0.5mm,1mm
② Series No:33	⑤ Blank:Standard J:Halogen-free Flame retardance UL94V-0	⑧ Contact alignment:S: single ⑨ Eccentric direction: Blank:standard type B:Eccentric type	⑪ SH:SMT horizontal mounting ⑫ Plating specifications: Blank:Gold plated (10)...Gold plating with nickel barrier 5,000pieces/reel (99)...Gold plating with nickel barrier 500pieces/reel
③ Blank:0.5mm pitch,1mm pitch M:0.4mm pitch			

Connector Dimensions

●0.4mm pitch, 0.5mm pitch type

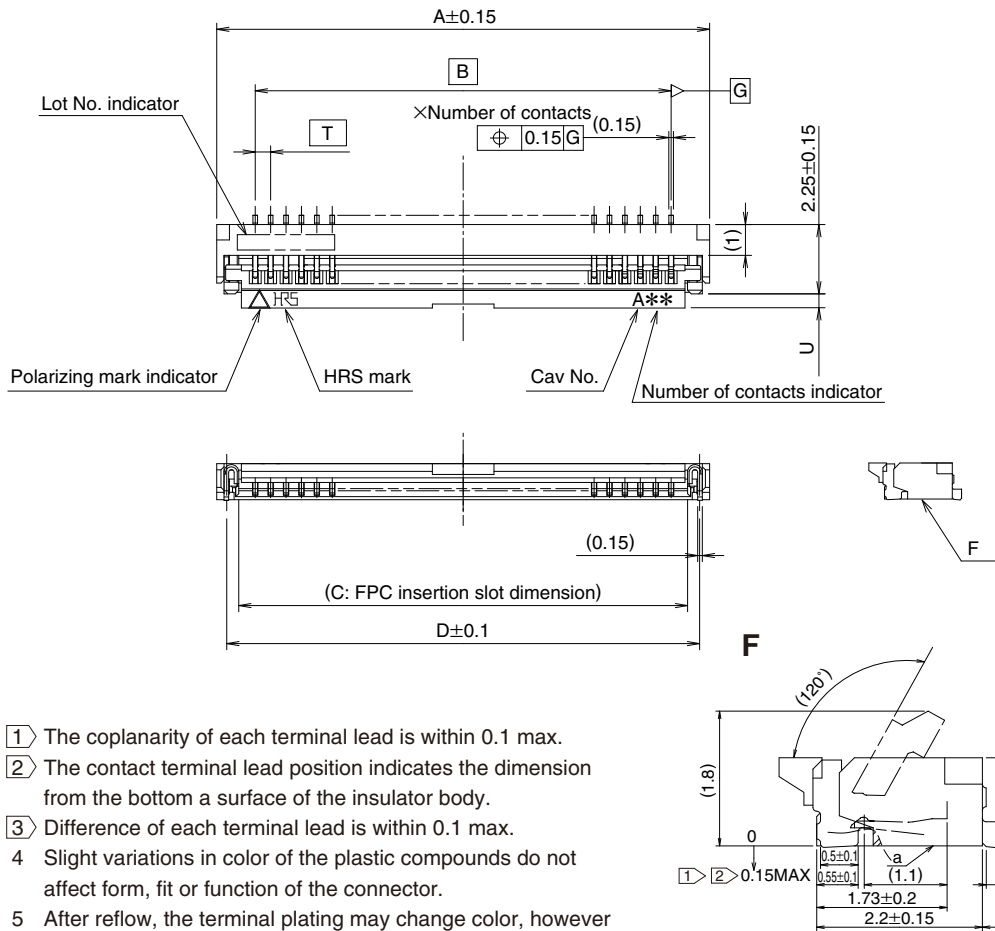

- Notes
- 1 The coplanarity of each terminal lead is within 0.1 max.
 - 2 The contact terminal lead position indicates the dimension from the bottom a surface of the insulator body.
 - 3 Difference of each terminal lead is within 0.1 max.
 - 4 Slight variations in color of the plastic compounds do not affect form, fit or function of the connector.
 - 5 After reflow, the terminal plating may change color, however this does not represent a quality issue.

Unit: mm

Part Number	CL No.	Number of Contacts	A	B	C	D	T	U
FH33-6S-0.5SH (**)	580-1301-1-**-	6	5	2.5	3.57	4.35	0.5	0.45
FH33-9S-0.5SH (**)	580-1303-7-**-	9	6.5	4	5.07	5.85	0.5	0.45
FH33-10S-0.5SH (**)	580-1304-0-**-	10	7	4.5	5.57	6.35	0.5	0.45
FH33-12S-0.5SH (**)	580-1302-4-**-	12	8	5.5	6.57	7.35	0.5	0.45
FH33-14S-0.5SH (**)	580-1305-2-**-	14	9	6.5	7.57	8.35	0.5	0.45
FH33-19S-0.5SH (**)	580-1307-8-**-	19	11.5	9	10.07	10.85	0.5	0.45
FH33-20S-0.5SH (**)	580-1317-1-**-	20	12	9.5	10.57	11.35	0.5	0.45
FH33-26S-0.5SH (**)	580-1306-5-**-	26	15	12.5	13.57	14.35	0.5	0.45
FH33-28S-0.5SH (**)	580-1300-9-**-	28	16	13.5	14.57	15.35	0.5	0.45
FH33-30S-0.5SH (**)	580-1312-8-**-	30	17	14.5	15.57	16.35	0.5	0.45
FH33-32S-0.5SH (**)	580-1310-2-**-	32	18	15.5	16.57	17.35	0.5	0.45
FH33-36S-0.5SH (**)	580-1311-5-**-	36	20	17.5	18.57	19.35	0.5	0.45
FH33-40S-0.5SH (**)	580-1308-0-**-	40	22	19.5	20.57	21.35	0.5	0.45
FH33-45S-0.5SH (**)	580-1316-9-**-	45	24.5	22	23.07	23.85	0.5	0.45
FH33M-16S-0.4SH (**)	580-1319-7-**-	16	8.3	6	6.87	7.65	0.4	0.45
FH33J-4S-0.5SH (**)	580-1329-0-**-	4	4	1.5	2.57	3.35	0.5	0.45
FH33J-10S-0.5SH (**)	580-1324-7-**-	10	7	4.5	5.57	6.35	0.5	0.45
FH33J-12S-0.5SH (**)	580-1328-8-**-	12	8	5.5	6.57	7.35	0.5	0.45
FH33J-16S-0.5SH (**)	580-1331-2-**-	16	10	7.5	8.57	9.35	0.5	0.45
FH33J-18S-0.5SH (**)	580-1334-0-**-	18	11	8.5	9.57	10.35	0.5	0.45
FH33J-19S-0.5SH (**)	580-1332-5-**-	19	11.5	9	10.07	10.85	0.5	0.45
FH33J-40S-0.5SH (**)	580-1330-0-**-	40	22	19.5	20.57	21.35	0.5	0.45
FH33MHJ-65S-0.4SH (**)	580-1325-0-**-	65	27.9	25.6	26.47	27.25	0.4	0.95

Note 1: Embossed reel packaging (5,000 pieces/reel, 500 pieces/reel).
Order by number of reels.

Cameras Applications



Automotive Driver Pilot



Live Streaming



Video Conference



Eye Tracker Biometric Detection

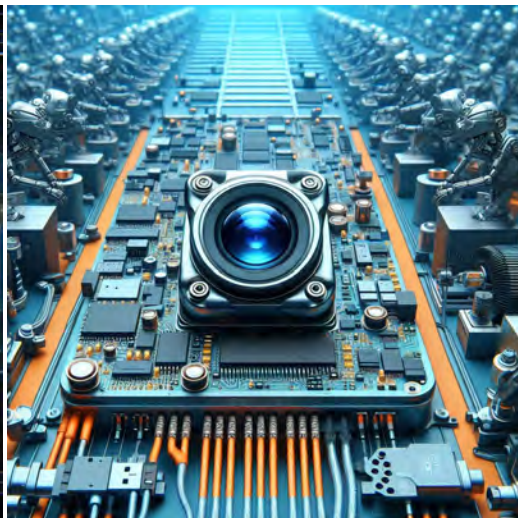

Machine Vision



Agricultural Monitor



Night Vision Security



Drone and Sports Eagle Eyes



Interactive Pet Camera



YDS CAMERA MODULE

your best camera partner

Camera Module Pinout Definition Reference Chart

OmniVision	Sony	Samsung	On-Semi	Aptina	Himax	GalaxyCore	PixArt	SmartSens	Sensors
Pin Signal		Description							
DGND GND		ground for digital circuit							
AGND		ground for analog circuit							
PCLK DCK		DVP PCLK output							
XCLR PWDN XSHUTDOWN STANDBY		power down active high with internal pull-down resistor							
MCLK XVCLK XCLK INCK		system input clock							
RESET RST		reset active low with internal pull-up resistor							
NC NULL		no connect							
SDA SIO_D SIOD		SCCB data							
SCL SIO_C SIOC		SCCB input clock							
VSYNC XVS FSYNC		DVP VSYNC output							
HREF XHS		DVP HREF output							
DOVDD		power for I/O circuit							
AFVDD		power for VCM circuit							
AVDD		power for analog circuit							
DVDD		power for digital circuit							
STROBE FSTROBE		strobe output							
FSIN		synchronize the VSYNC signal from the other sensor							
SID		SCCB last bit ID input							
ILPWM		mechanical shutter output indicator							
FREQ		frame exposure / mechanical shutter							
GPIO		general purpose inputs							
SLASEL		I2C slave address select							
AFEN		CEN chip enable active high on VCM driver IC							
MIPI Interface									
MDN0 DN0 MD0N DATA_N DMO1N		MIPI 1st data lane negative output							
MDP0 DP0 MD0P DATA_P DMO1P		MIPI 1st data lane positive output							
MDN1 DN1 MD1N DATA2_N DMO2N		MIPI 2nd data lane negative output							
MDP1 DP1 MD1P DATA2_P DMO2P		MIPI 2nd data lane positive output							
MDN2 DN2 MD2N DATA3_N DMO3N		MIPI 3rd data lane negative output							
MDP2 DP2 MD2P DATA3_P DMO3P		MIPI 3rd data lane positive output							
MDN3 DN3 MD3N DATA4_N DMO4N		MIPI 4th data lane negative output							
MDP3 DP3 MD3P DATA4_P DMO4P		MIPI 4th data lane positive output							
MCN CLKN CLK_N DCKN		MIPI clock negative output							
MCP CLKP MCP CLK_P DCKN		MIPI clock positive output							
DVP Parallel Interface									
D0 DO0 Y0		DVP data output port 0							
D1 DO1 Y1		DVP data output port 1							
D2 DO2 Y2		DVP data output port 2							
D3 DO3 Y3		DVP data output port 3							
D4 DO4 Y4		DVP data output port 4							
D5 DO5 Y5		DVP data output port 5							
D6 DO6 Y6		DVP data output port 6							
D7 DO7 Y7		DVP data output port 7							
D8 DO8 Y8		DVP data output port 8							
D9 DO9 Y9		DVP data output port 9							
D10 DO10 Y10		DVP data output port 10							
D11 DO11 Y11		DVP data output port 11							

www.YDSCAM.com sales@ydscam.com Phone (WeChat, QQ): (+86) 177 2732 6718

All rights reserved @ YingDeShun Co. Ltd. Specifications subject to change without notice.

Camera Reliability Test

Reliability Inspection Item		Testing Method	Acceptance Criteria	
Category	Item			
Environmental	Storage Temperature	High 60°C 96 Hours	Temperature Chamber	No Abnormal Situation
		Low -20°C 96 Hours	Temperature Chamber	No Abnormal Situation
	Operation Temperature	High 60°C 24 Hours	Temperature Chamber	No Abnormal Situation
		Low -20°C 24 Hours	Temperature Chamber	No Abnormal Situation
	Humidity	60°C 80% 24 Hours	Temperature Chamber	No Abnormal Situation
	Thermal Shock	High 60°C 0.5 Hours Low -20°C 0.5 Hours Cycling in 24 Hours	Temperature Chamber	No Abnormal Situation
Physical	Drop Test (Free Falling)	Without Package 60cm	10 Times on Wood Floor	Electrically Functional
		With Package 60cm	10 Times on Wood Floor	Electrically Functional
	Vibration Test	50Hz X-Axis 2mm 30min	Vibration Table	Electrically Functional
		50Hz Y-Axis 2mm 30min	Vibration Table	Electrically Functional
		50Hz Z-Axis 2mm 30min	Vibration Table	Electrically Functional
	Cable Tensile Strength Test	Loading Weight 4 kg 60 Seconds Cycling in 24 Hours	Tensile Testing Machine	Electrically Functional
Electrical	ESD Test	Contact Discharge 2 KV	ESD Testing Machine	Electrically Functional
		Air Discharge 4 KV	ESD Testing Machine	Electrically Functional
	Aging Test	On/Off 30 Seconds Cycling in 24 Hours	Power Switch	Electrically Functional
	USB Connector	On/Off 250 Times	Plug and Unplug	Electrically Functional



Camera Inspection Standard

Inspection Item		Inspection Method	Standard of Inspection		
Category	Item				
Appearance	FPC/ PCB	Color	The Naked Eye	Major Difference is Not Allowed.	
		Be Torn/Chopped	The Naked Eye	Copper Crack Exposure is Not Allowed.	
		Marking	The Naked Eye	Clear, Recognizable (Within 30cm Distance)	
	Holder	Scratches	The Naked Eye	The Inside Crack Exposure is Not Allowed	
		Gap	The Naked Eye	Meet the Height Standard	
		Screw	The Naked Eye	Make Sure Screws Are Presented (If Any)	
		Damage	The Naked Eye	The Inside Crack Exposure is Not Allowed	
	Lens	Scratch	The Naked Eye	No Effect On Resolution Standard	
		Contamination	The Naked Eye	No Effect On Resolution Standard	
		Oil Film	The Naked Eye	No Effect On Resolution Standard	
		Cover Tape	The Naked Eye	No Issue On Appearance.	
	Function	Image	No Communication	Test Board	Not Allowed
			Bright Pixel	Black Board	Not Allowed In the Image Center
Dark Pixel			White board	Not Allowed In the Image Center	
Blurry			The Naked Eye	Not Allowed	
No Image			The Naked Eye	Not Allowed	
Vertical Line			The Naked Eye	Not Allowed	
Horizontal Line			The Naked Eye	Not Allowed	
Light Leakage			The Naked Eye	Not Allowed	
Blinking Image			The Naked Eye	Not Allowed	
Bruise			Inspection Jig	Not Allowed	
Resolution			Chart	Follows Outgoing Inspection Chart Standard	
Color			The Naked Eye	No Issue	
Noise			The Naked Eye	Not Allowed	
Corner Dark			The Naked Eye	Less Than 100px By 100px	
Color Resolution			The Naked Eye	No Issue	
Dimension	Height	The Naked Eye	Follows Approval Data Sheet		
	Width	The Naked Eye	Follows Approval Data Sheet		
	Length	The Naked Eye	Follows Approval Data Sheet		
	Overall	The Naked Eye	Follows Approval Data Sheet		

YDSCAM Package Solutions

YDS Camera Module



Complete with Lens Protection Film



Tray with Grid and Space



Place Cameras on the Tray

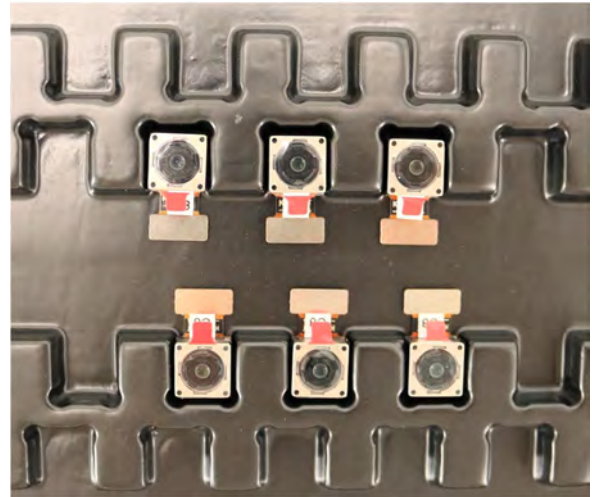

YDSCAM Package Solutions

Full Tray of Cameras

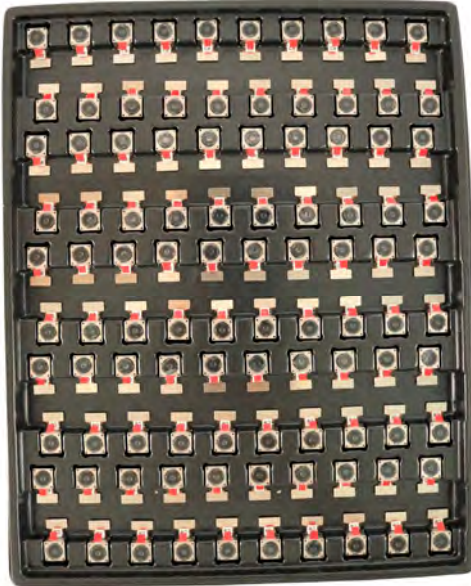

Cover Tray with Lid

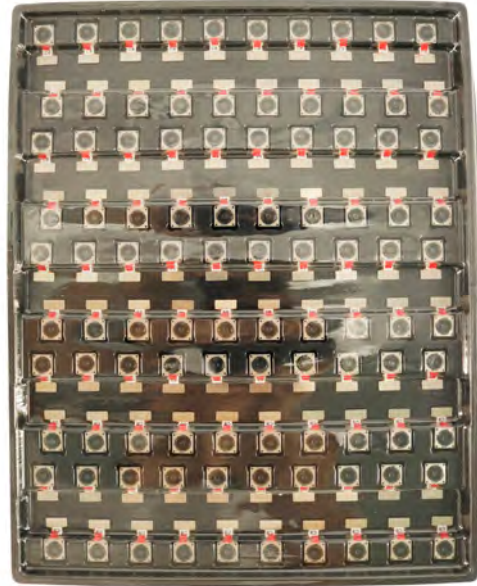

Place Tray into Anti-Static Bag



Vacuum the Anti-Static Bag



YDSCAM Package Solutions

Sealed Vacuum Anti-Static Bag with Labels

1. Model and Description 2. Quantity 3. Manufacturing Date Code 4. Caution



YDSCAM Package Solutions

Place Foam Sheets Between Tray Bags



Foam Sheets are Larger Than Trays



Place Foam Sheets and Trays into Box



Foam Sheets are Tightly Fitting in Box



Seal the Carbon Box



Label the Carbon Shipping Box





YDSCAM Package Solutions

USB Camera Module

Complete with Lens Protection Film

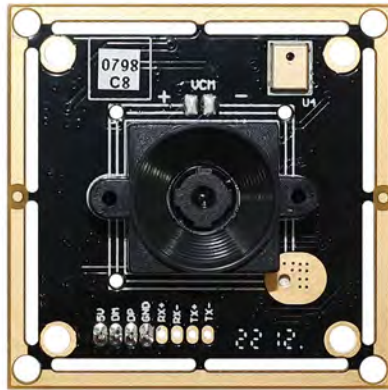

Place Camera Sample into Anti-Static Bag

Place USB Cameras into Tray



Seal the Tray with Anti-Static Bag

Label the Carbon Shipping Box



YDSCAM Package Solutions

Place Camera Sample into Anti-Static Bag



Place Connectors into Anti-Static Bag



Label the Sample Bags



Place Connectors into Reel



Place Samples into the Carbon Box



Place Connectors into the Carbon Box





YDS CAMERA MODULE

your best camera partner

Company YDSCAM

YingDeShun Co. Ltd. (YDS) was established in 2017, a next-generation technology driven manufacturer specialized in research, design, and produce of audio and video products. YDS is occupying 20,000 square feet automated plants with 100 employees of annual throughput 30,000,000 units cameras.

YDS provides OEM, ODM design, contract manufacturing, and builds the camera products. You may provide the requirements to us, even with a hand draft, our sales and engineering work together to meet your needs. We consider ourselves your last-term partner in developing practical and innovative solutions.

Our team covers everything from initial concept development to mass produced product. YDS specializes in customized camera design, raw material, electronic engineering, firmware/software development, product testing, and packing design. Our experienced strategic supply systems offer a robust and dependable manufacturing capacity for orders of various sizes.

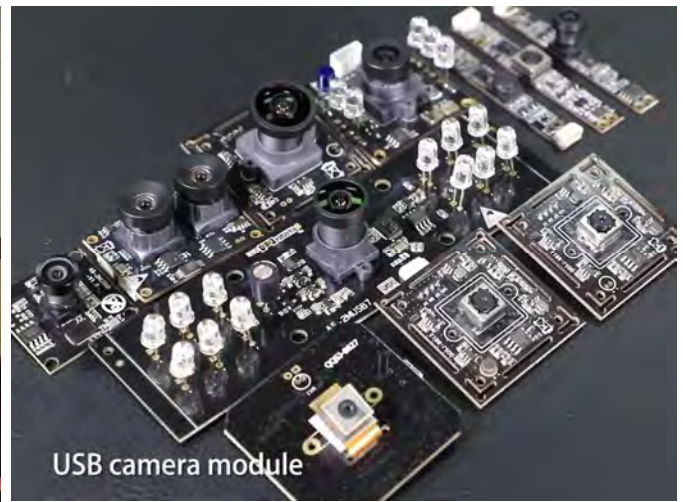

Limited Warranty

YDS provides the following limited warranty if you purchased the Product(s) directly from YDS company or from YDS's website www.YDSCAM.com. Product(s) purchased from other sellers or sources are not covered by this Limited Warranty. YDS guarantees that the Product(s) will be free from defects in materials and workmanship under normal use for a period of one (1) year from the date you receive the product ("Warranty Period").

For all Product(s) that contain or develop material defects in materials or workmanship during the Warranty Period, YDS will, at its sole option, either: (i) repair the Product(s); (ii) replace the Product(s) with a new or refurbished Product(s) (replacement Product(s) being of identical model or functional equivalent); or (iii) provide you a refund of the price you paid for the Product(s).

This Limited Warranty of YDS is solely limited to repair and/or replacement on the terms set forth above. YDS is not reliable or responsible for any subsequent events.



www.YDSCAM.com sales@ydscom.com Phone (WeChat, QQ): (+86) 177 2732 6718

All rights reserved @ YingDeShun Co. Ltd. Specifications subject to change without notice.



YDS CAMERA MODULE

your best camera partner

YDS Strength

Powerful Factory



Professional Service



Promised Delivery



www.YDSCAM.com sales@ydscam.com Phone (WeChat, QQ): (+86) 177 2732 6718

All rights reserved @ YingDeShun Co. Ltd. Specifications subject to change without notice.